

Main applications

- Hot-runners
- Plastic extruders
- Plastic injection presses
- Blowers
- Plastic and rubber processing machines
- Wrapping machines
- Packaging machines
- Thermal processes with electric heating

Main features

- Three versions:
 - MASTER - independent temperature control and communication unit
 - SLAVE - independent temperature control unit
 - EXPANSION - for three-phase loads
- Protection: IP20
- Universal temperature input, accuracy 0.2%
- Configurable digital input
- Logic output or "cooling" relay
- Load current detection with integrated Current and Voltage Transformer
- Heat/cool PID, selection of cooling fluid, self-tuning, auto-tuning "one-shot", soft-start
- 4 generic alarms, LBA and HB alarms
- 2 configurable relay outputs
- Field bus for Master
 - Standard: "Modbus RTU" with Serial 485 optically
 - Option: "PROFIBUS DP", "CANopen", "DeviceNet"

PROFILE

Extremely flexible and compact rear panel instrument. Consists of a "base" containing the PID microprocessor controller which holds a functional module such as: 5/10/15Amp power solid state relay, double continuous output, double relay, single relay. Utilized mainly for heating hot extrusion channels, injection, and in all multizone configurations. In addition, thanks to the use of popular field buses, Geflex_Multifunction can be integrated in various architectures.

Models and communication

The system has high communication capacity and interfaces without limitation with the automation environment. Three standard protocols are available: Modbus RTU, Profibus DP and CANopen implemented in the Geflex "master," which in turn communicates with up to nine Geflex "slaves" by means of an internal bus. Every Geflex can tune to the network communication speed (baud) with a self-learning sequence. In addition to connecting to PLCs,

terminals, and PCs, the "master" is able to control a control loop

Modules

All of the following modules are completely interchangeable.

Power.

Modules for three current levels: 5, 10, 15 Amp at 230/440V, single phase. Each zone is completely independent from the adjacent one. In addition, 3-phases loads can be controlled by adopting a Master/Slave unit to which two Expansion units are connected.

Double Continuous Output.

Module with two continuous outputs configurable in current or voltage (0/4...20mA, 0...10V) by means of selectors on the module.

Double relay.

Module with two NO relay outputs (3A, 250V).

The two control outputs are totally configurable.

Single relay.

Single NO relay (12A, 250V).

The control output is totally configurable.

Mechanics

The mechanical elements have been carefully designed and tested for maximum ease of installation and to guarantee high resistance to vibration and thermal stress.

Diagnostic LEDs

The lower section has three LEDs that indicate the functional state of the main output, ERROR LED, and RUN OK LED.

The upper section has a lamp which signal the presence of voltage (on power modules).

Temperature input

The temperature input is universal and can be connected to a wide variety of signal types: thermocouples, resistance thermometers, input from 0...60mV, 0...20mA, 0...1Vdc, transmitters, definable only by software, without the need for external adapter shunts.

Accuracy of 0.2% guarantees excellent control of the heat process.

Integrated fuse

The base also contains the fuse pro-

protecting the SSR: the user does not have to do any additional wiring.

PID

The control algorithm adapts to every type of heat process.

Up to 14 different control modes are available: from simple ON/OFF control to single or double action heat/cool PID; for cooling, simply indicate the fluid being used.

Sophisticated and efficient algorithms for automatic tuning of control parameters provide precise process control without user intervention.

Outputs and digital input

The instrument can have up to 3 outputs: a cooling relay (3A, 250V), logic (24Vdc, 35mA) or continuous (0/4...20mA, 0...10V) and two optional alarm relay outputs (3A, 250V). The outputs are freely configurable via software.

By means of internal bus, each "slave" can activate the two relay outputs on the "master" following alarm conditions to create electrical clearance or block signals set to assure safe operation of technological systems.

This further reduces electromechanical wiring.

At the logic level, there are 4 generic alarms configurable as: absolute, deviation, direct, reverse, window, in latching or non-latching mode, disabled at power-up.

With the isolated digital input always available, you can select one of the two pre-settable set points select Manual-Automatic mode, reset the alarms memory, or enable the hold function.

Safety, diagnostics

At the logic level, there are 4 completely configurable generic alarms.

Efficient diagnosis of the control loop prevents breakdowns and lets the user take timely action (for example, in case of broken probe or load failure).

The LBA alarm carefully controls the control loop, while the current transformer (option) lets you directly monitor the load and activate the HB alarm in case of current failure or SSR in short.

In addition, the voltage transformer lets the user monitor line voltage,

power, and energy, with important benefits for safety and plant efficiency.

Software can be used to define the state of the alarm outputs or a preset power level to be supplied in case of a broken probe, thereby assuring continuous service of the individual module.

LEDs signal any fault in real time, and powerful diagnostics is available via serial.

A simple command from the digital input deactivates the control zone by "software shutdown" of the instrument.

Programming

The Geflex modules can be programmed via a supervisor (industrial PC, HMI) or via the GFX_OP terminal (see accessories). Both solutions provide complete configurability and diagnostics for every Geflex (Master/Slave).

For even simpler configuration, a programming kit (from notebook PC or palm PC) is available, composed of an IRDA interface unit and WINSTRUM (a guided program for Windows environment - see technical sheet).

TECHNICAL DATA

INPUTS

Input range: 0...60mV.

Sampling time: 120msec.

Accuracy: 0,2%fs \pm 1 scale points at 25°C.

Resolution : < 2 μ V for range 60mV.

Input filter: 0...20,0sec.

Zero offset adjustable in range:

-999...+999 scale points.

Main input

Thermocouple, Resistance Thermometer, Linear.

Application: process variable.

Thermocouples:

ITS90: J, K, R, S, T, custom.

Cold junction compensation: internal, with automatic compensation.

Resistance Thermometer:

Pt100 DIN 43710, J Pt100, custom.

Linears/Transmitters:

range 0...60mV, 0...20mA, 0...1Vdc (configurable within limits).

Possible 32 segment custom linearization.

Load control with option

TA, TV internal:

Ammeter :

range 0...5/10/15Aac

Applications: control of current absorbed by load.

Line tension:

range 0...480Vac.

Applications: control line tension, power.

Digital input

PNP 24V, 8mA (isol. 3500V)

Applications: Man/Auto, Loc/Rem,

Hold, Reset alarms, Select setpoint, shut down software.

Auxiliary input (option)

Potentiometers \geq 1K Ω

0/2...10V (Ri > 100K Ω)

0/4...20mA (Ri > 500 Ω).

OUTPUTS

Max 3 Relays / 1 Logic + 2 Relays.

- Relay

(Up to 3), NO, max 3A, 250V resistive load.

Application: cooling, alarms.

- Logic

24Vdc, 35mA.

Application: cooling, alarms.

- Continuous

0...10V; 0/4...20mA

Application: cooling, alarms.

**DIGITAL COMMUNICATION,
FIELD BUS**

Asynchronous serial transmission.

Standard protocol: MODBUS RTU

RS485 2 wires, 1200...19200 baud.

Optional protocol: CAN OPEN

10K...1M bit/sec, PROFIBUS DP

9,6...12Mbit/sec.

SafetyDetection of short circuit or opening
of input probe, open loop alarm

(LBA), load fault alarm (HB),

overheat SCR.

PROCESS CONTROL FUNCTIONS**Control**PID, PI, PD, P, On/Off, heat, cool,
heat + cool with fluid selection.Manual/Automatic: Bumpless or with
manual forcing of output.**Tuning**- Self-tuning: calculation of PID para-
meters at system start.- Auto-tuning: continuous adjustment
of PID.**Special functions**Soft-start, power limitation, software
shut down.**Alarms**

Up to 4:

absolute, deviation, symmetric, direct,

reverse, latching and non, LBA, HB.

Reference: PV, SP, auxiliary input
(for HB).**Multiset**Double setpoint with gradient selecta-
ble from digital input**POWER SUPPLY**24Vdc \pm 25%, 5W**POWER MODULE**

	5A		10A		15A	
NOMINAL VOLTAGE	230Vac	440Vac	230Vac	440Vac	230Vac	440Vac
RATED WORKING VOLTAGE	24...253Vac	24...484Vac	24...253Vac	24...484Vac	24...253Vac	24...484Vac
NON-REPETITIVE VOLTAGE	500Vp/800Vp		500Vp/800Vp		500Vp/800Vp	
SWITCHING VOLTAGE FOR ZERO	$\leq 20V$					
RATED FREQUENCY	50...60Hz					
CORRENTE NOMINALE AC1	5A		10A		15A	
NON-REPETITIVE OVERCURRENT (t=20ms)	80A		120A		160A	
dv/dt CRITICAL WITH OUTPUT DEACTIVATED	500V/ μ s					
RATED ISOLATION VOLTAGE IN/OUT	2500V					
WORKING TEMPERATURE	(see dissipation curves)					
CONNECTION	FASTON 4,8 x 0,5 mm					
Weight	50gr		50gr		120gr	
Protection	IP20					

DESCRIPTION OF FACEPLATE

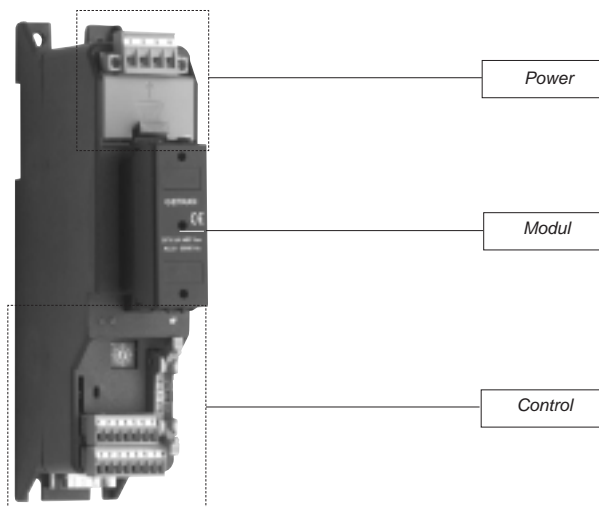

POWER

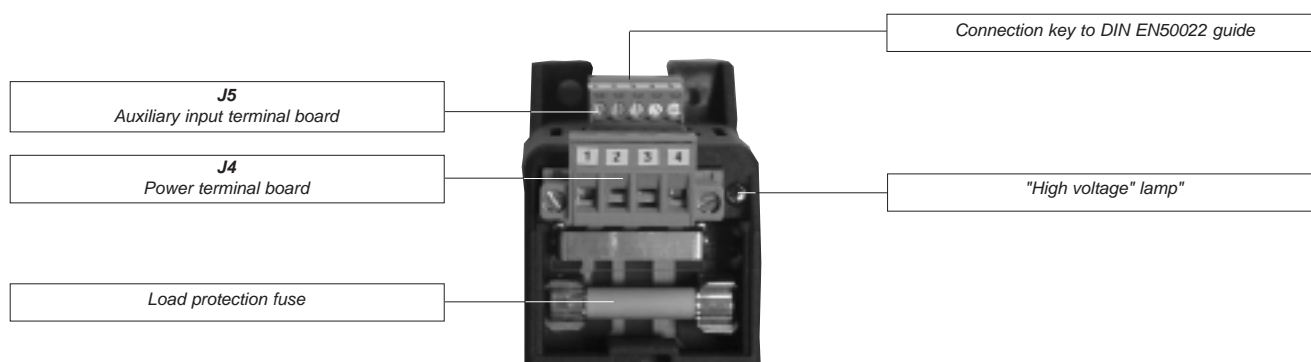

CONTROL

Led L2 "Error" LED (red)
 Activates when one of the following errors is present:
 LO = process variable value is < di Lo.S
 HI = process variable value is > di Hi.S
 Sbr = broken probe or input values beyond maximum limits
 Err = third wire broken for Pt100, PTC or input values below minimum limits
 (ex.: for CT with incorrect connection)

Led L1 "Status" LED (green)
 Freely settable with parameter
197 (Ld.St).
 Default setting is 16
 (RUN flashes)

Connection to previous module
 (Slave and Expansion modul only)

J1
 Probe and power supply terminal board

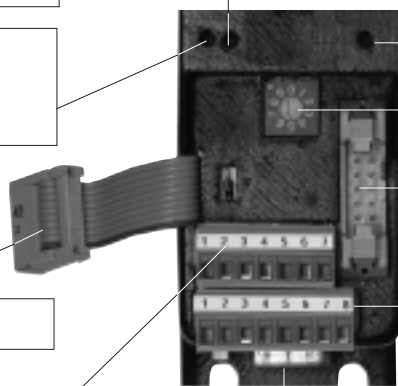

Led L3 "Main" (yellow)
 Follows trend of
 heat output (OUT1)

Fieldbus node selection

J3
 Connection to next module

J2
 Output terminal board

Fieldbus connection
 (Master moduls only)

DISSIPATION CURVES

Rated current curves based on room temperature.

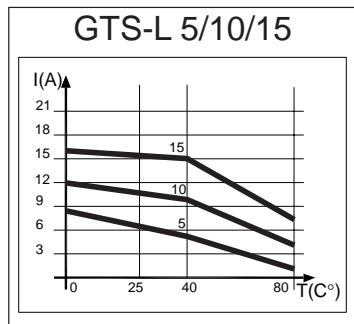

Dissipated Thermal Power:
 $P_{ds} = 1.6 \times I_{rms}$ (W)
 I_{rms} = rated current of single-phase load

TABLE FOR SELECTION OF WIRE TERMINALS FOR POWER AND SIGNAL TERMINAL BOARDS

	Flexible wire conductor	Conductor with prod terminal with insulating collar
SIGNAL	0,14 - 1,5mm ² / 28-16AWG	0,25 - 0,5mm ² / 24-20AWG
POWER	0,2 - 2,5mm ² / 24-12AWG	0,25 - 2,5mm ² / 24-12AWG
Cross-cut screwdriver, blade 0.4 x 2.5mm		

DIMENSIONS AND CUTOUT

Base with "5A solid state power unit" module or "Double continuous output" or "Double Relay"

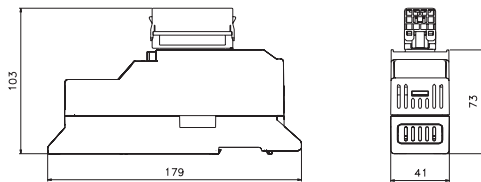

Base Mounting on electromechanical plate with quick coupling to DIN EN50022 guide or with 5mA screws

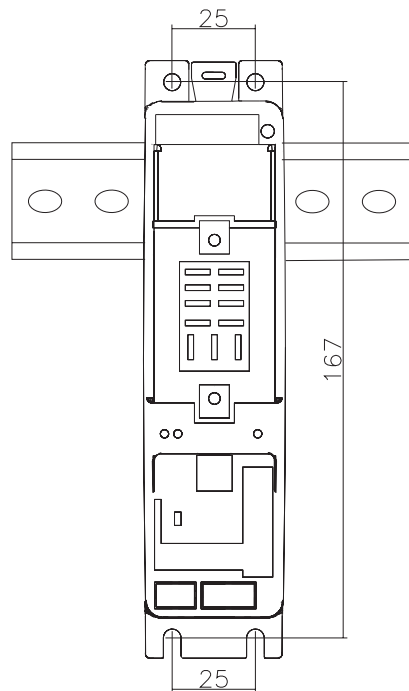

Base with "10/15A power solid state unit" module

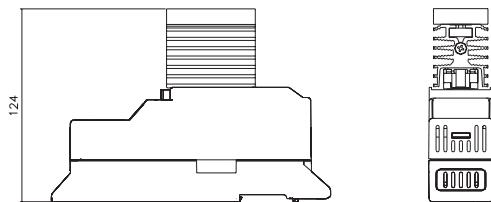

Base with "Base with Relay" module"

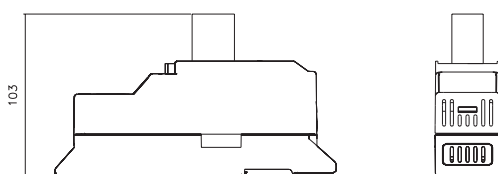

CONNECTION EXAMPLES

Connection of MASTER + SLAVE modules

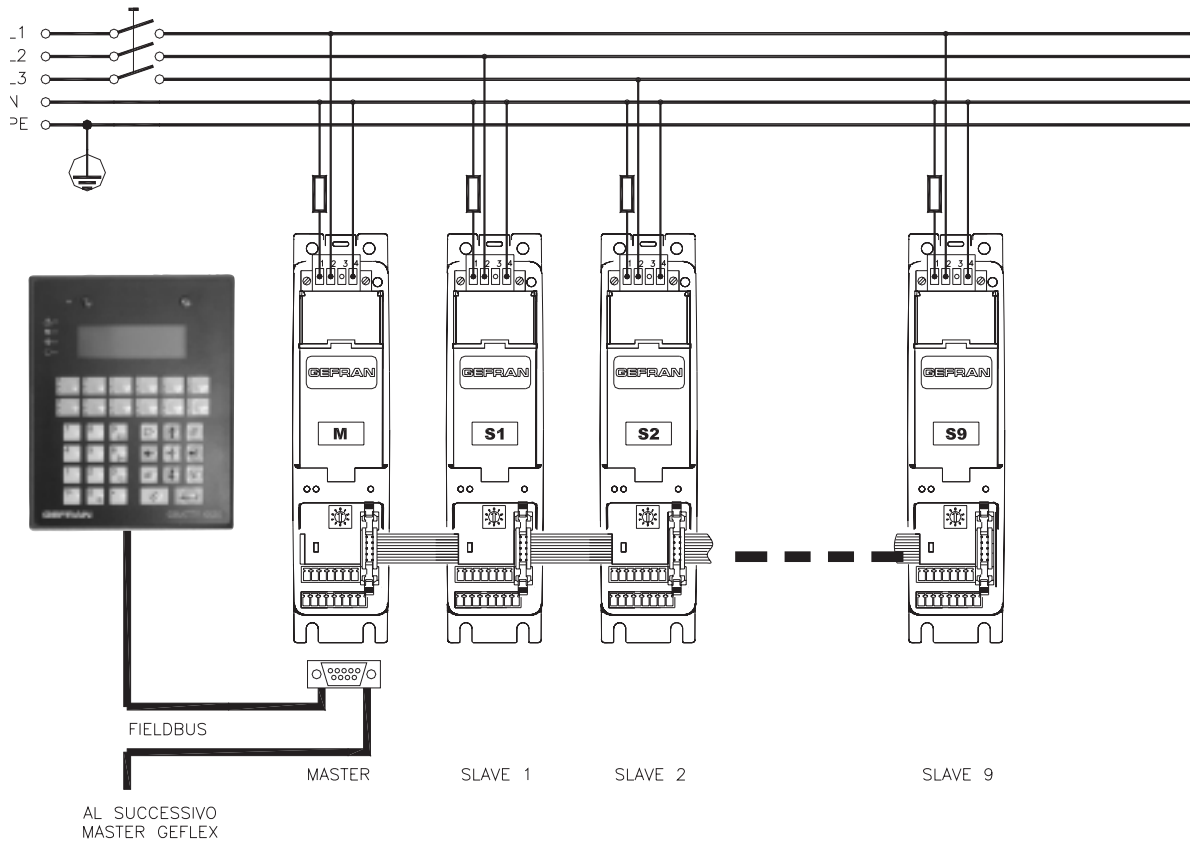

Three-phase connection

STELLA CON NEUTRO

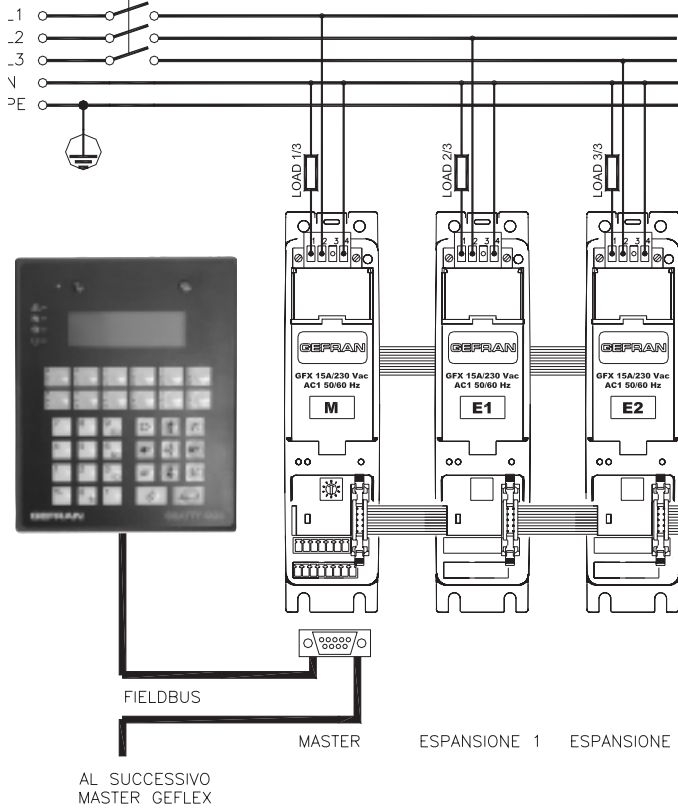

TRIANGOLO

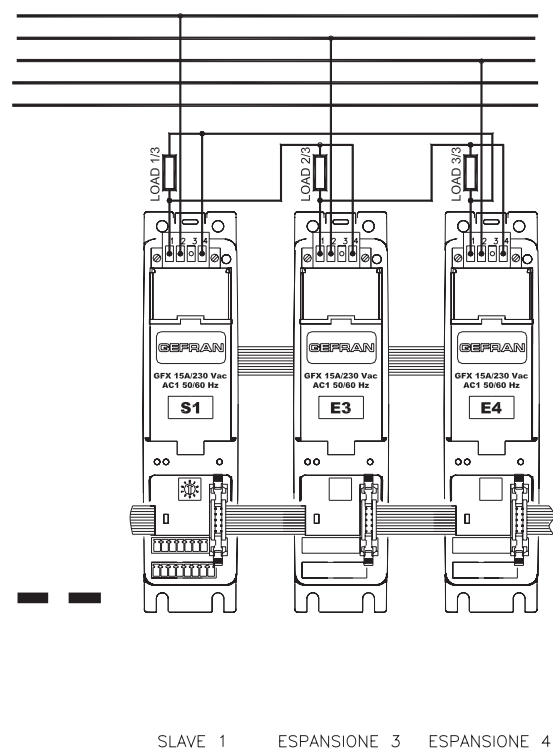

Power connections

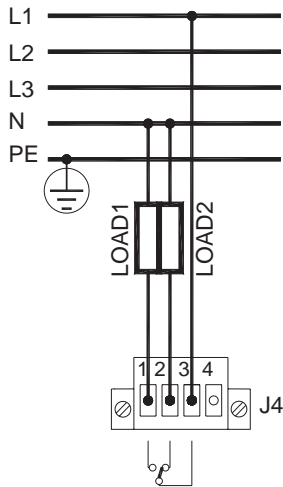

Single relay module "R"

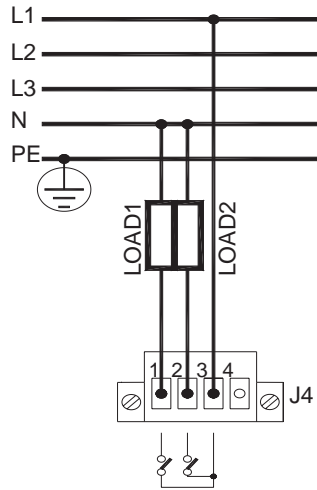

Double relay module "RR"

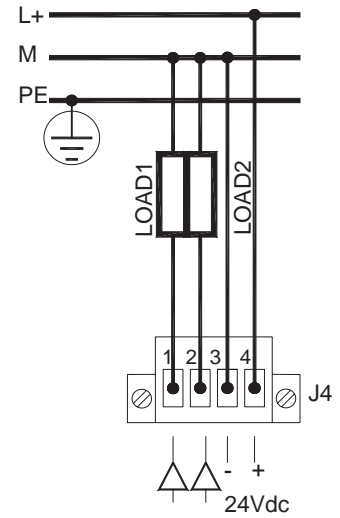

Double analog output module "CC"
Power supply to "M" must be the same as to "J1"

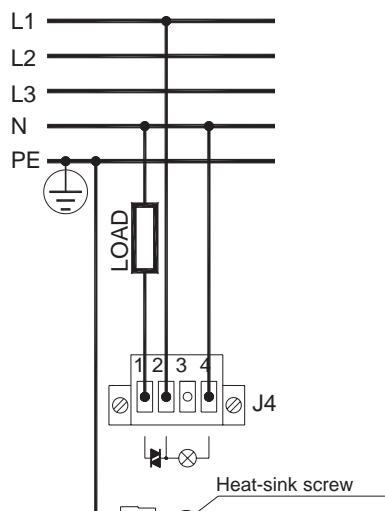

"5/10/15" solid state power unit module (connection with neutral)

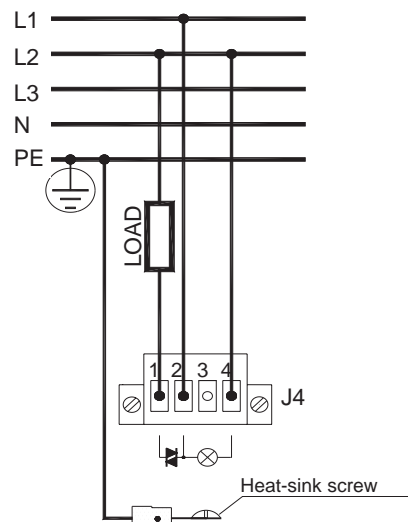

"5/10/15" solid state power unit module (connection without neutral)

Input / Output / Power Supply connections

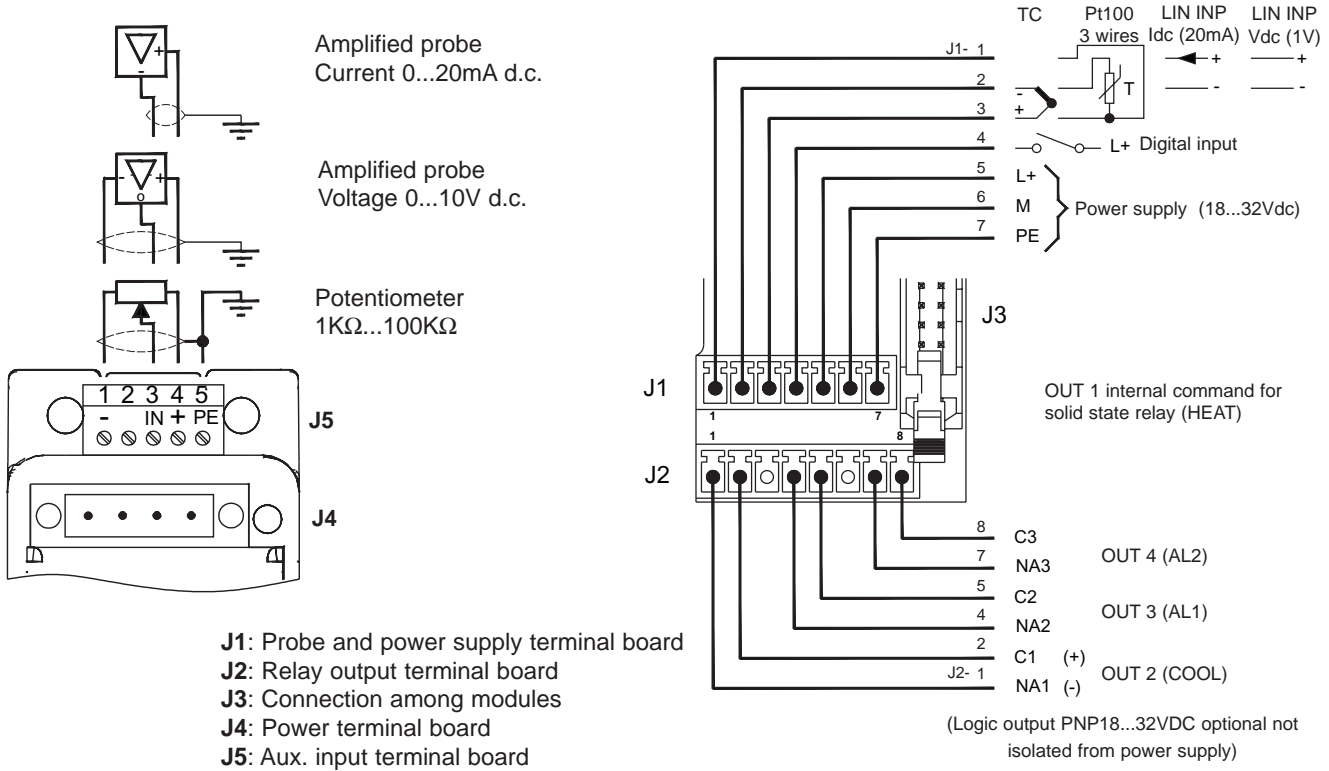

Serial connections

“MODBUS” serial

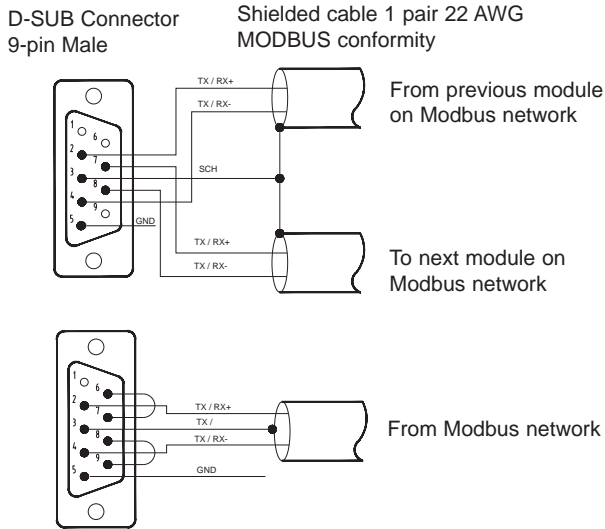

We advise you to connect pins 6 to 7 and pins 8 to 9 on the connector of the last Geflex on the Modbus network to insert the line termination.
It is also advisable to connect the "GND" signal between Modbus devices having a line distance > 100m.

“DeviceNet” serial

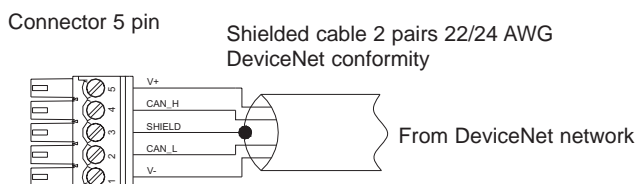

We advise you to connect a 120Ω 1/4W resistance between the "CAN_L" and "CAN_H" signals at both ends of the DeviceNet network.

“PROFIBUS DP” serial

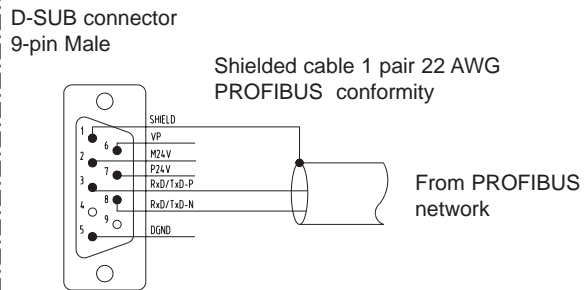

We advise you to connect a 220Ω 1/4W resistance between the "RxD/TxD-P" and "RxD/TxD-N" signals, a 390Ω 1/4W resistance between the "RxD/TxD-P" and "Vp" signals, and a 390Ω 1/4W resistance between the "RxD/TxD-N" and "DGND" signals at both ends of the Profibus network.

“CANopen” serial

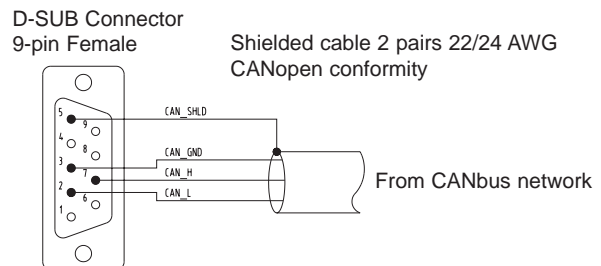

We advise you to connect a 120Ω 1/4W resistance between the "CAN_L" and "CAN_H" signals at both ends of the CANbus network.

ORDER CODE

Master

GFX-M2 B15 / 0 M 0 RR P 0

FUNCTIONAL MODULE	
Without power solid state unit	B15
With 5A power solid state unit	5
With 10A power solid state unit	10
With 15A power solid state unit	15
With single relay module	R
With double relay module	RR
With double continuous output module 0...10V (0/4...20mA)	CC

RATED VOLTAGE	
None	0 *
230Vac	230
440Vac	440

SERIAL COMMUNICATION	
MODBUS RTU	M
PROFIBUS DP	P
CANopen	C
DeviceNet	D

DIAGNOSTIC	
0	None
** C0	Current Transformer
** CV	Current Transformer + Voltage Transformer
IM	Multifunction input 0/4...20mA, (0...10V)
PO	Potentiometer input

DIGITAL INPUT	
P	PNP Digital Input

AUXILIARY OUTPUTS	
RR	2 Relays

COOLING OUTPUT	
0	Absent
D	Logic
R	Relay
C	Continuous output 0...10V (0/4...20mA)

* with versions only GFX-M2-B15/0-X-X-XX-X-X
 GFX-M2-R/0-X-X-XX-X-X
 GFX-M2-RR/0-X-X-XX-X-X
 GFX-M2-CC/0-X-X-XX-X-X

** with versions only GFX-M2-B15/0-X-X-X-XX-X-X
 GFX-M2-5/X-X-X-XX-X-X
 GFX-M2-10/X-X-X-XX-X-X
 GFX-M2-15/X-X-X-XX-X-X

Slave

GFX-S2 B15 / 0 0 D 00 P 0

FUNCTIONAL MODULE	
Without power solid state unit	B15
With 5A power solid state unit	5
With 10A power solid state unit	10
With 15A power solid state unit	15
With single relay module	R
With double relay module	RR
With double continuous output module 0...10V (0/4...20mA)	CC

RATED VOLTAGE	
None	0 *
230Vac	230
440Vac	440

DIAGNOSTIC	
0	None
** C0	Current Transformer
** CV	Current Transformer + Voltage Transformer
IM	Multifunction input 0/4...20mA, (0...10V)
PO	Potentiometer input

DIGITAL INPUT	
P	PNP Digital Input

AUXILIARY OUTPUTS	
00	Absent
RR	2 Relays

COOLING OUTPUT	
0	Absent
D	Logic
R	Relay
C	Continuous output 0...10V (0/4...20mA)

* with versions only GFX-S2-B15/0-X-X-XX-X-X
 GFX-S2-R/0-X-X-XX-X-X
 GFX-S2-RR/0-X-X-XX-X-X
 GFX-S2-CC/0-X-X-XX-X-X

** with versions only GFX-S2-B15/0-X-X-X-XX-X-X
 GFX-S2-5/X-X-X-XX-X-X
 GFX-S2-10/X-X-X-XX-X-X
 GFX-S2-15/X-X-X-XX-X-X

Expansion

GFX-E2 B15 / 230 0 0 00 0 0

FUNCTIONAL MODULE	
Without power solid state unit	B15
With 5A power solid state unit	5
With 10A power solid state unit	10
With 15A power solid state unit	15

RATED VOLTAGE	
230Vac	230
440Vac	440

DIAGNOSTIC	
0	None
C0	Current Transformer
CV	Current Transformer + Voltage Transformer

* with versions only GFX-E2-B15/230-0-0-00-0-0

GEFRAN spa reserves the right to make aesthetic or functional changes at any time and without notice.

Conformity C/UL/US File no. C/UL/US File no. E198546

The instrument conforms to the European Directives 2004/108/CE and 2006/95/CE with reference to the generic standards : EN 61326-1 EN (product), EN 61010-1 (safety)

GEFRAN

GEFRAN spa via Sebina, 74 - 25050 Provaglio d'Iseo (BS)
Tel. 03098881 - fax 0309839063
Internet: <http://www.gefran.com>

GEFLEX GFX_M - 06-2010_ENG